

**OPERATION MANUAL ver.4**



**TEMPERATURE CONTROLLED  
LEAD-FREE SOLDERING STATION**

**RX-802AS**

**KEEP THIS MANUAL FOR FUTURE REFERENCE**



**WARNING**

Before using the soldering station, read the Operation Manual. Failure to follow the safety precautions and instructions in this manual could result in serious injury and property damage.

Thank you for buying a *goot* soldering station. Your new soldering station has been engineered and manufactured to the *goot* high standards for dependability, ease of operation, and operator safety. If you follow the instructions and safety precautions in this manual and use the soldering station properly and only for what it is intended, you will enjoy years of safe, reliable service. Thank you again for buying a *goot* soldering station.

## Safety Mark Definitions

Following the WARNINGS and CAUTIONS in this manual will allow for the safe and proper use of the soldering station, and should protect the operator from injury and operators' property against damage.



### **WARNING**

Failure to obey a safety warning could result in serious injury or death to yourself or to others. Always follow the safety precautions to reduce the risk of electric shock, fire or personal injury.



### **CAUTION**

Failure to obey a safety caution may result in a minor or moderate injury to yourself or to others. Always follow the safety precautions to reduce the risk of electric shock, fire or personal injury.

# 1 Table of Contents

1. Table of Contents / Specifications.....	3
2. Introduction .....	4
2.1 Unpacking .....	4
2.2 Name of Parts .....	5
2.3 Soldering Iron Stand ST-21 Instructions.....	7
3. Rules for Safe Operation.....	8
4. Operation Instructions .....	10
4.1 Changing the Set Temperature.....	10
4.2 Calibration of the Tip Temperature.....	11
4.3 Calibration Function .....	12
4.4 Sleep Function .....	13
4.5 Setting the Shutdown Function .....	16
4.6 Setting the Soldering -time Alarm.....	17
4.7 Setting the Temperature Range for the Alarm.....	18
4.8 Setting the Alarm Sound .....	19
4.9 Setting the Temperature Display .....	20
4.10 Key Lock Function .....	21
4.11 How to Restore the Default Settings.....	24
5. Maintenance .....	26
5.1 How to Change the Tip.....	26
5.2 How to Change the Grip Rubber.....	27
5.3 Housing Cleaning .....	27
5.4 How to Use and Maintain a Lead-Free Soldering Iron.....	27
6. Troubleshooting .....	28
7. Replacement Tips .....	29
8. Replacement Parts .....	30
9. Parameters .....	31

## Specifications

MODEL		RX-802AS
Voltage		110, 120, 130, 220, 230, 240V AC
Power Consumption		80W
Soldering Iron Voltage/ Wattage		24V AC/72W
Temperature Setting Range		50°C (122°F)– 450°C (842°F)
Dimensions	Soldering Unit	158mm (w/o cord bushing)
	Control Unit	115 mm (W) X 98 (H) X146(D) mm
Weight	Soldering Unit	Approx. 28g (w/o cord)
	Control Unit	Approx. 1.8kg (w/o cord)
Control Unit to Soldering Unit cord Length		1.2m
AC Power Cord Length		1.2m 3 core cord (ground plug)
Leak Voltage		Less than 2mV
Ground Resistance		Less than 2Ω
Accessories		Soldering Iron Stand <b>ST-21</b>

## 2 Introduction

### 2-1 Unpacking

Please make sure that all the items listed below are included, and that the soldering station (control unit and soldering unit) function properly. If any items are missing or damaged, please contact your **goot** distributor. Please store the packaging for future shipment or repair.

#### Packing List

- Control Unit
- Soldering Unit : RX-80GAS
- Soldering Iron Stand :ST-21
- Operation Manual

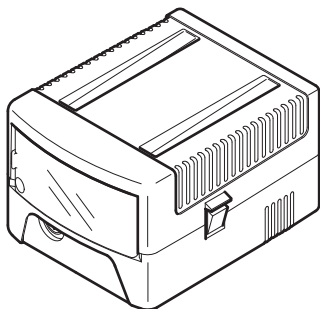

Control Unit

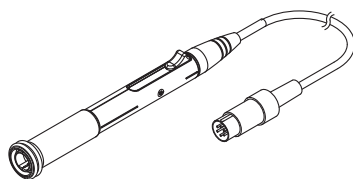

Soldering Unit : RX-80GAS

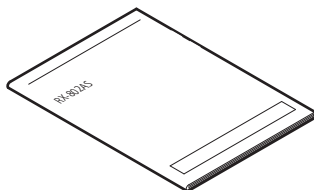

Operation Manual

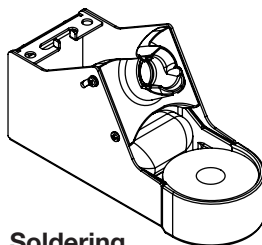

Soldering  
Iron Stand : ST-21

## 2-2 Name of Parts

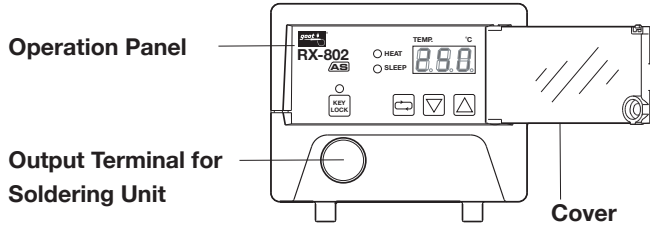

### FRONT VIEW

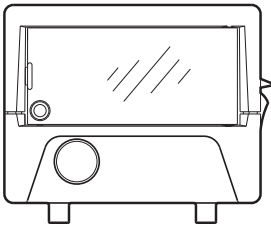

### SIDE VIEW

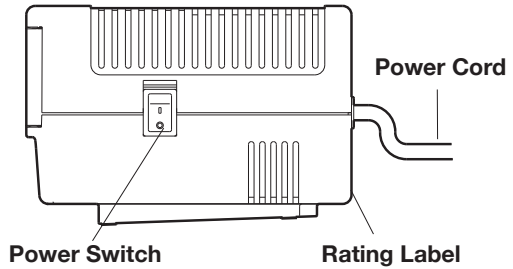

Tip (Sold separately)

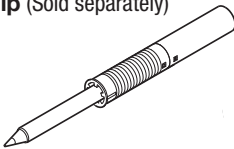

### CAUTION

[4-2] calibration of the tip temperature is requires after attaching the tip. Otherwise, there may be some difference between the actual tip temperature add the set temperature of the unit.

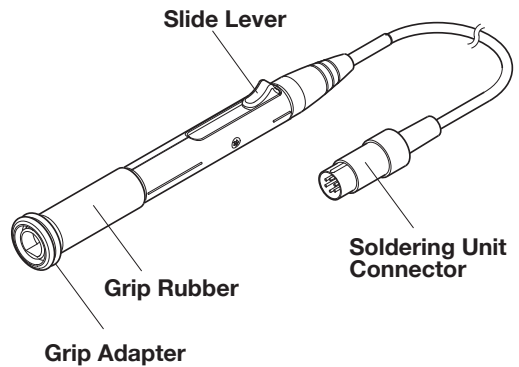

## ■Operation Panel

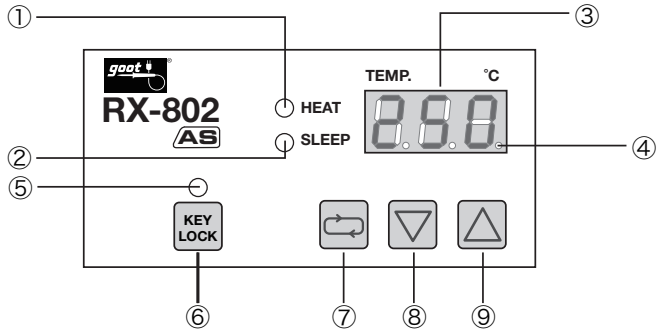

### 1. HEAT lamp

Lights up when the heater is ON.

### 2. SLEEP lamp

Flashes while setting the SLEEP function. The flashing of the sleep lamp will increase 30seconds before entering SLEEP mode.

Lights up when the unit enters SLEEP mode.

### 3. TEMP. display

When the power is turned ON or when SLEEP mode is exited, the TEMP display shows the tip temperature rise to the set temperature. The TEMP display shows the set temperature when it is reached.

### 4. ALARM lamp (to the right of the last digit in the temperature display)

Lights up when the tip temperature is within the DIF range.

Turns off when the tip temperature is out of the DIF range.

Flashes when the tip temperature is out of the upper and lower temperature limits.

### 5. KEY LOCK lamp

Flashes while setting the Key Lock function.

Lights up when the unit is in Key Lock mode.

### 6. KEY LOCK key

Use to set the Key Lock function.

Use to lock and unlock the keypad.

### 7. SETTING key

This key is pressed when starting and completing the temperature setting process. It is also used during the parameter changing procedure to move to the next parameter and to complete the parameter setting process by pressing continuously for 3 seconds.

### 8. DOWN key

This key is used to reduce the used to reduce the temperature and change the parameter.

### 9. UP key

This key is used to increase the temperature and change the parameter.

## 2-3 Soldering Iron Stand ST-21 Instructions



### WARNING

●High temperatures. Handle with care. ●To avoid injury, do not touch the metal part of the stand. ●To prevent fire, do not use the ST-21 near flammable substances.



### CAUTION

●Always place the stand on a stable worktable, or other stable location, to prevent injury or accident from dropping it. ●To avoid splattering solder scrap, do not swipe the tip of the iron across the brass wool. This is dangerous. ●To prevent fire or personal injury, be sure that the stand has cooled sufficiently before storing it.

## INSTRUCTION FOR USE

Rub the soldering-iron tip on the moistened sponge. Use the hole of the sponge for better cleaning. Alternatively, push the soldering-iron tip in and out of the brass wool a few times. Stab, not swipe.



●To avoid rust, do not pour water on the brass wool. ●Sponge tray and holding flange (of the front opening) are made of phenol. Be aware that extended tip-contact may result in their deterioration. ●Remove the collected solder scrap regularly.

Tip Stand ST-21C

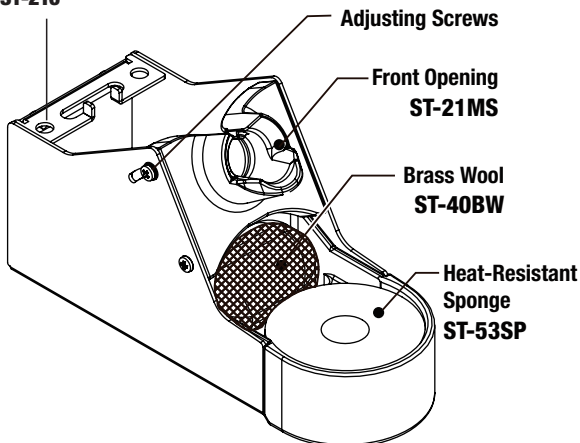

The angle of the front opening can be adjusted by loosening screws on the side.

## 3 Rules for Safe Operation

	<p><b>WARNING</b></p> <p>The <b>RX-802AS</b> is an anti-static model. Be sure to properly ground the soldering station using a grounded receptacle to prevent electric shocks and anti-static. If it is not properly grounded, electric shocks will occur. As the soldering station uses conductive materials, please be careful not to touch any electrical power source or a serious injury will result.</p>
-----------------------------------------------------------------------------------	----------------------------------------------------------------------------------------------------------------------------------------------------------------------------------------------------------------------------------------------------------------------------------------------------------------------------------------------------------------------------------------------------------------

### 1. DO NOT USE IN DANGEROUS ENVIRONMENTS.

Do not use the soldering station in damp or wet locations or expose it to external environmental conditions, particularly rain. Never use it in an explosive atmosphere. The heat from the heater can ignite fumes. Be sure that the work area is well ventilated.

### 2. KEEP CHILDREN AND BYSTANDERS AWAY FROM THE SOLDERING STATION.

Do not let bystanders touch the soldering station. All bystanders should be kept a safe distance from the work area.

### 3. USE FOR THE RIGHT JOB.

Your soldering station is an electrical tool used to solder parts and melt solder. Do not use the soldering station for any other purpose. For example: The soldering station should never be used to warm water or other liquids.

### 4. WEAR PROPER APPAREL, SAFETY GLASSES, GLOVES AND MASK.

Do not wear loose clothing (such as a necktie). Tie up long hair. Clothing or hair can burn on contact with the tip or surrounding heated parts.

### 5. CONNECT TO THE SPECIFIED AC POWER SUPPLY.

The power voltage for this soldering station is indicated at the back of the control unit. Never plug the soldering station into any other voltage.

### 6. DO NOT ABUSE THE POWER CORD AND INSPECT IT PERIODICALLY.

Never carry your soldering station by its power cord or yank the power cord to disconnect it from the receptacle. Keep the power cord away from heat, oil and sharp edges.



**7. USE STAND PROVIDED.**

Be sure to use the **ST-21** soldering iron stand included with the soldering station. If this stand is not used, the plastic parts (adapter ring and/or handpiece) of the soldering iron unit could be damaged. Position the soldering iron stand on a flat work-surface or bench.

**8. CONCERNING THE TIP.**

After turning OFF the power switch, allow the tip to cool naturally. Never use any other method to cool it down. For example: Water should never be poured or sprinkled on the tip to cool it down.

**9. CONCERNING THE POWER CORD.**

**IF THE POWER CORD IS DAMAGED THEN THE SOLDERING STATION SHOULD BE RETURNED TO THE DISTRIBUTOR FOR REPLACEMENT.**







## 4

## 4-1 Changing the Set Temperature

When the station is shipped the temperature is set at 250°C (482°F). The temperature can be set from 50°C (122°F) to 450°C (842°F).

\*For the steps given in the operation instructions, only °C is used.

**Example:** Changing the temperature from 250°C (482°F) to 340°C (644°F).

Key Operation		TEMP Display
1	Press the  key.	Displays flashes 
2	Press and hold the  key until the display shows .	
3	Press the  key.  <b>Setting completed</b>	

**NOTE )** If nothing is pressed for 30seconds during setting the temperature, the temperature on display will be recorded and the display will return to the normal conditions.

\*The set temperature should be set at 50°C(90°F) higher than the sleep temperature (see the section 4-4), otherwise you will not be able to set the set temperature value. (Example: If the set temperature is set at 200°C(392°F), the sleep temperature must be 150°C(302°F) or under.





→Refer to the Parameters table (on ) for an explanation of the display messages.

## 4-2 Calibration of the Tip Temperature

**RX-80HRT-B** is mounted in the standard unit. When changing to a different type of tip, the calibration of the tip temperature is required before starting soldering work. Otherwise, there may be a difference between the actual tip temperature and the set temperature of the unit.

### How to set the TIP No.

(Example : When using an 1.6D tip, set to TIP No. 2.)

Key Operation	TEMP Display
<p>1 Press and hold the  key for over 3 seconds continuously.</p>	
<p>2 Press the  key so that the number <b>2</b> is displayed.</p>	
<p>3 Press and hold the  key for over 3 seconds continuously.</p> <p style="text-align: center;"><b>Setting completed</b></p>	<p style="text-align: center;"><b>Returns to the set temperature display.</b></p>

### Tip No. List

The temperature can be calibrated easily by inputting the TIP number which is engraved on the tip.

MODEL	TIP SHAPE	TIP NO.
RX-80HRT-SB	SB	3
RX-80HRT-B	B	1
RX-80HRT-2B	2B	1
RX-80HRT-BM	BM	1
RX-80HRT-LB	LB	2
RX-80HRT-LBJ	LBJ	2
RX-80HRT-1BC	1BC	1
RX-80HRT-2.3BC	2.3BC	1
RX-80HRT-3BC	3BC	1
RX-80HRT-0.5C	0.5C	3
RX-80HRT-1C	1C	4
RX-80HRT-2C	2C	4
RX-80HRT-3C	3C	2
RX-80HRT-4C	4C	1
RX-80HRT-4.7C	4.7C	0

MODEL	TIP SHAPE	TIP NO.
RX-80HRT-2CD	2CD	4
RX-80HRT-3CD	3CD	2
RX-80HRT-0.8D	0.8D	2
RX-80HRT-1.2D	1.2D	2
RX-80HRT-1.6D	1.6D	2
RX-80HRT-2.4D	2.4D	1
RX-80HRT-3.2D	3.2D	1
RX-80HRT-5.4D	5.4D	0
RX-80HRT-3K	3K	1
RX-80HRT-4.5K	4.5K	1
RX-80HRT-5.5K	5.5K	1
RX-80HRT-4.5KH	4.5KH	1







The above tip number (TIP NO.) may be changed without notice, due to design changes, etc. Be sure to check the actual engraved tip number of your tip (at the base).

### 4-3 Calibration Function

The **RX-802AS** can be calibrated using a tip thermometer. Generally speaking, when measuring the tip temperature of the **RX-802AS** with a standard tip thermometer, the measured temperature will usually be lower than that of the actual tip temperature displayed on the **RX-802AS** control unit display. This could be because the tip is not coming into contact properly with the sensor of the tip thermometer. It could also be because once the tip thermometer comes into contact with the **RX-802AS** soldering tip, the metallic parts in the thermometer (for example alumel chromel in the Type-K thermocouple) conduct heat which transfers away from the **RX-802AS** tip. This results in the thermometer indicating a slightly lower temperature than the one in the **RX-802AS** display.

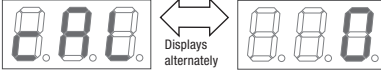
#### How to Calibrate the Temperature

(Example : Where the set temperature is 300°C (572°F), tip thermometer value is 295°C (563°F), and the calibration value to be input is 5°C (9°F).)

Key Operation	TEMP Display
<p>1 Press and hold the  key for over 3 seconds continuously.</p>	
<p>2 Press the  key once.</p>	
<p>3 Press the  key so that <b>5</b> (°C) is displayed.</p>	
<p>4 Press and hold the  key for over 3 seconds continuously.</p> <p style="text-align: center;"><b>Setting completed</b></p>	<p style="text-align: center;"><b>Returns to the set temperature display.</b></p>

Calibration value is set to 0 before shipping. The tip number must be changed when the different type of tip is mounted according to **4-2 Calibration of the Tip Temperature**.

## 4-4 Sleep Function

The sleep start timer (CT) function automatically lowers the temperature of the tip after a preset period of inactivity. This function reduces power consumption and helps extend soldering tip life. This sleep function can be used with the shutdown function (see 4-5) together.

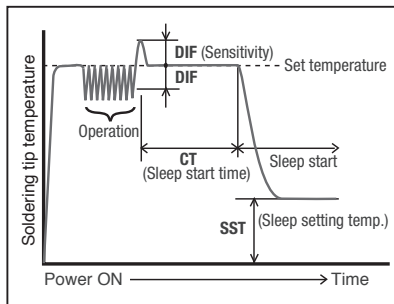







Sleep mode can be exited by rubbing the tip on the moist sponge. But when Sleep temperature (SST) is 99°C or below, Sleep mode cannot be exited because the temperature changing range is too small. To exit Sleep mode, press any key on the control panel and the tip will return to the set temperature.

Unit: °C

Set to 200°C (392°F) before shipping.

**Example** : Changing the sleep temperature from 200°C (392°F) to 150°C (302°F).

Key Operation	TEMP Display
<p>1 Press and hold the  key for over 3 seconds continuously.</p>	 <p>Displays alternately</p>
<p>2 Press the  key twice.</p>	 <p>Displays alternately</p>
<p>3 Press the  key, until the display changes to <b>150</b>.</p>	 <p>Displays alternately</p>
<p>4 Press and hold the  key for over 3 seconds continuously.</p> <p style="text-align: center; background-color: black; color: white; padding: 2px;"><b>Setting completed</b></p>	<p style="text-align: center;"><b>Returns to the set temperature display.</b></p>

To use Sleep function manually during the operation, press and hold the  key for one second continuously. (Active Sleep function) While setting the Sleep function, the Sleep lamp will flash.

The flashing of the Sleep lamp will increase 30 seconds before entering Sleep mode.













When the soldering station has entered Sleep mode, the Sleep lamp will change from flashing to continuously lit, and the display will alternate between "SLP" and the temperature.

When the power is turned ON, no work is started and nothing is pressed on the keypad, the soldering station will automatically enter Sleep mode either 10 minutes after the power has been turned ON or in twice the set sleep time (CT), whichever time is longer. However, if soldering is started or keys are pressed on the control panel, the soldering station will automatically revert to the set sleep start time.

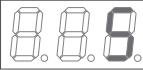
### Setting the Sleep start time (CT) Unit: mins.



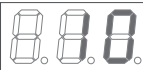



Set to 5 minutes before shipping.

**Example :** Changing the sleep start time from 5 to 10 minutes.

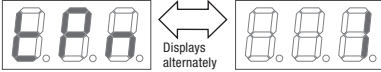
Key Operation	TEMP Display
<p>1 Press and hold the  key for over 3 seconds continuously.</p>	   <p>Displays alternately</p>
<p>2 Press the  key three times.</p>	   <p>Displays alternately</p>
<p>3 Press the  key, until the display changes from 5 to 10.</p>	   <p>Displays alternately</p>
<p>4 Press and hold the  key for over 3 seconds continuously.</p> <p style="text-align: center;"><b>Setting completed</b></p>	<p style="text-align: center;"><b>Returns to the set temperature display.</b></p>

By setting the CT (Sleep start time) to 0.00 the sleep function will be turned off and the SLEEP lamp will go out.

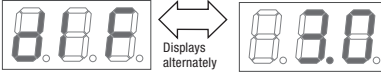
**Setting the Sleep Sensitivity (DIF) Unit : °C**      **Example :** Changing the Sleep Sensitivity value to 2 °C (3.6°F) to 3.0°C (5.4°F).

Key Operation	TEMP Display
<p>1 Press and hold the  key for over 3 seconds continuously.</p>	 <p>Displays alternately</p>
<p>2 Press the  key four times.</p>	 <p>Displays alternately</p>
<p>3 Press the  key, until the display changes to <b>3.0</b>.</p>	 <p>Displays alternately</p>
<p>4 Press and hold the  key for over 3 seconds continuously.</p> <p style="text-align: center;"><b>Setting completed</b></p>	<p style="text-align: center;"><b>Returns to the set temperature display.</b></p>

#### NOTE )

\*If the sleep sensitivity value (**DIF**) is set too high, there is a possibility that the sleep function will be activated even during soldering. If this happens, reduce the sleep sensitivity value.

\*Sleep sensitivity value (**DIF**) can be set anywhere between 0°C (0°F) and 20.0°C (36.0°F).

\*If the sleep sensitivity value (**DIF**) is set to low, there is a possibility that the sleep function will not be activated even after passing Sleep Start Time (**CT**) because the tip temperature can't be stabilized within the range of **DIF**. If this happens, increase the **DIF** value.

## 4-5 Setting the Shutdown Function

When the unit is not operated during the preset time, the unit is automatically shutdown. Even if the user forgets to turn OFF the unit, this Shutdown function works to keep the unit inactive, and prevents accidents such as fire.

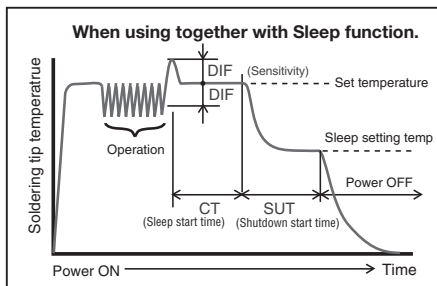
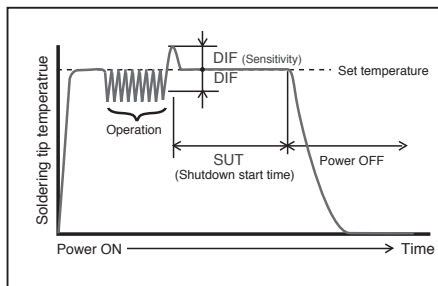

**Setting the Shutdown start time (SUT)**

**Example :** Changing the Shutdown start time from 60 to 30. Unit : mins

### Key Operation

### TEMP Display

1 Press and hold the  key for over 3 seconds continuously.

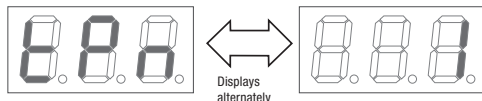

2 Press the  key five times.

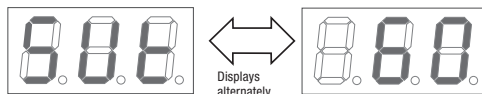

3 Press the  key, until the display changes to **30**.

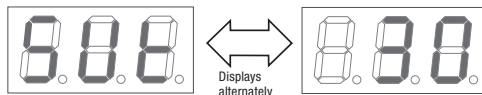

4 Press and hold the  key for over 3 seconds continuously.

**Returns to the set temperature display.**

**Setting completed**

When SUT (Shutdown start time) value is set to 0, the shutdown function is OFF. The display will alternate between Sdn and the temperature when the unit is in the shutdown mode. The LED under the one digit on the TEMP window lights when the temperature



becomes under 50°C (122°F). To use the unit again after shutting down, turn the power OFF and then ON again to operate the unit.

## 4-6 Setting the Soldering-time Alarm

The **RX-802AS** sounds an alarm, when the soldering iron is left in contact with the component being soldered past the time set. This function prevents inexperienced operators from overheating the component.

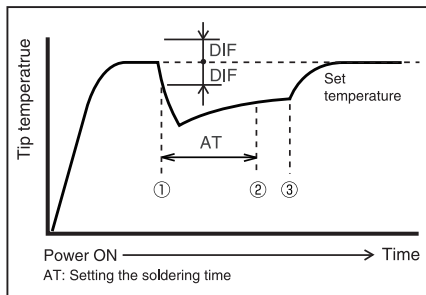





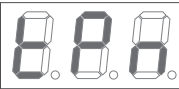
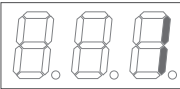

- (1) **RX-802AS** starts the soldering-time count down, when the tip temperature exceeds the set parameter.
- (2) The alarm sounds after the soldering-time preset is reached. The display will also flash twice at this point.
- (3) Lift the tip from the component being soldered when the alarm sounds.

To turn off the alarm function, set the preset time value at 0.3 or less, and then [---] is displayed.

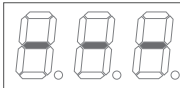
### Setting the soldering start time

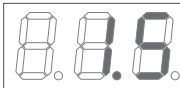
**Example** : Changing the soldering time from 0 to 1.5. Unit : seconds

Key Operation	TEMP Display
<p><b>1</b> Press and hold the  key for over 3 seconds continuously.</p>	 ↔  <small>Displays alternately</small>
<p><b>2</b> Press the  key 6 times to display "At".</p>	 ↔  <small>Displays alternately</small>
<p><b>3</b> Press the  key, until the display changes from --- to 1.5.</p>	 ↔  <small>Displays alternately</small>
<p><b>4</b> Press and hold the  key for over 3 seconds continuously.</p> <p style="text-align: center;"><b>Setting completed</b></p>	<p style="text-align: center;"><b>Returns to the set temperature display.</b></p>

## 4-7 Setting the Temperature Range for the Alarm

This function indicates to the operator with the sound of the alarm, when the tip temperature goes past the set parameter. The illustration on the right shows when the alarm will sound: The diagonal lines represent outside the temperature parameters.

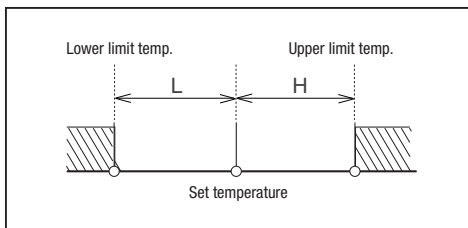





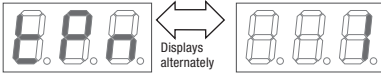

The alarm can be set from 3 to 100°C, for the upper limit and the lower limit respectively.

To turn off this function, set the preset value at 3 °C or lower, for the upper limit and the lower limit respectively. The display will then show [--].

### Setting the alarm range

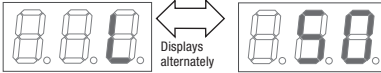





The upper limit and the lower limit are set to 50°C respectively, before shipping

Key Operation	TEMP Display
<p>1 Press and hold the  key for over 3 seconds continuously.</p>	
<p>2 Display "H" or "L", by pressing the  key.</p>	 Upper Temperature Limit
<p>3 Change the preset temperature by pressing the   key.</p>	 Lower Temperature Limit   Lower Temperature Limit
<p>4 Press and hold the  key for over 3 seconds continuously.</p> <p style="text-align: center;"><b>Setting completed</b></p>	<p style="text-align: center;"><b>Returns to the set temperature display.</b></p>

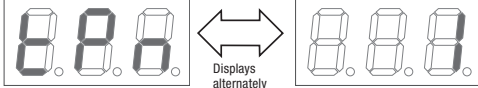
## 4-8 Setting the Alarm Sound

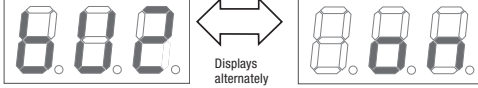

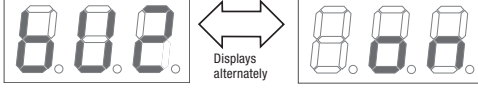
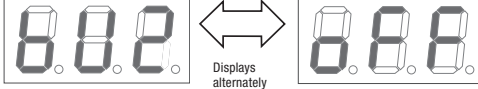





This setting switches the alarm ON and OFF. The initial setting is ON (the alarm sounds). Set to OFF for mute (no sound).

### Setting the alarm sound

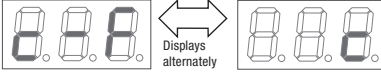
Key Operation	TEMP Display
<p>1 Press and hold the  key for over 3 seconds continuously.</p>	 <p>Displays alternately</p>
<p>2 Press the  key nine times.</p>	 <p>Displays alternately</p>
<p>3 Press the  key to set to <b>ON</b>.</p> <p>Press the  key to set to <b>OFF</b>.</p>	 <p>Displays alternately</p>  <p>Displays alternately</p>
<p>4 Press and hold the  key for over 3 seconds continuously.</p> <p><b>Setting completed</b></p>	<p><b>Returns to the set temperature display.</b></p>

## 4-9 Setting the Temperature Display

The temperature can be viewed in Celsius or in Fahrenheit.  
The temperature display is set to Celsius (°C) before shipping.

Key Operation	TEMP Display
<p>1 Press and hold the  key for over 3 seconds continuously.</p>	 <p>Displays alternately</p>
<p>2 Press the  key ten times.</p>	 <p>Displays alternately</p>
<p>3 Press the  key to change the format to <b>F</b>. (Fahrenheit °F)</p> <p>Press the  key to change the format to <b>C</b>. (Fahrenheit °C)</p>	 <p>Displays alternately</p>  <p>Displays alternately</p>
<p>4 Press and hold the  key for over 3 seconds continuously.</p> <p style="text-align: center;"><b>Setting completed</b></p>	<p style="text-align: center;"><b>Returns to the set temperature display.</b></p>

## 4-10 Key Lock Function

The Key Lock function locks the temperature and parameter settings. Therefore the temperature and parameters cannot be changed by any unauthorized personnel. Authorized personnel may use a code number to set, or release the Key Lock function.









The code number is not set before shipping.

- The code number can be set using any three-digit number from 001 to 999.
- When the code number is set correctly, the number will flash 5 times.
- If an incorrect code number is input, the display will show 'NG', and return to the initial display.

The Key Lock is set and released by the same procedure.











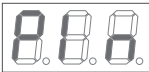

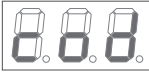
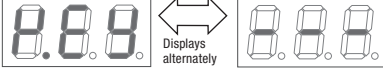

### Setting and Releasing the Code Number

**Example :** The code number is 123

Key Operation	TEMP Display
<p>1 Press the  key.</p>	  <p>Displays alternately</p>
<p>2 Input the the desired code number using the   keys</p>	
<p>3 Press the  key.</p> <p><b>Setting completed</b></p>	 <p>Flashes 5 times</p> <p>↓</p> <p><b>Returns to the set temperature display.</b></p>

## How to Change the Code Number

**Example** : When changing the code number from 123 to 234.











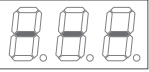

Key Operation	TEMP Display
<p>1</p> <p>Press the  key.</p>	  <p>Displays alternately</p>
<p>2</p> <p>Press and hold the  key for over 3 seconds continuously.</p>	  <p>Displays alternately</p>
<p>3</p> <p>Press the   keys so that the present code number is displayed</p>	
<p>4</p> <p>Press the  key.</p>	  <p>Displays alternately</p>
<p>5</p> <p>Input the desired new code number using the   keys.</p>	
<p>6</p> <p>Press the  key.</p> <p style="text-align: center;"><b>Setting completed</b></p>	 <p>Flashes 5 times</p> <p style="text-align: center;">↓</p> <p><b>Returns to the set temperature display.</b></p>

## Resetting the Code Number

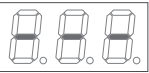
If you forget the code number, follow the procedure below to delete the code number and reset the key lock.

This procedure releases the key lock function which means that unauthorized persons can change temperature and/or parameter settings. Please keep this manual with authorized personnel only and in a safe place for future reference.

### How to Reset the Code Number

Key Operation	TEMP Display
<p>1 Press the  key.</p>	  ↔  <small>Displays alternately</small>
<p>2 Press and hold the  and the  key simultaneously for over 3 seconds.</p>	 ↔  <small>Displays alternately</small>
<p>3 Press the   keys so that the present code number is displayed</p>	
<p>4 Press the  key.</p> <p><b>Resetting completed</b></p>	 <small>Flashes 5 times</small>  <b>Returns to the set temperature display.</b>

\*NOTE: The number '471' is the unique number to reset. This can be used even if the password is also set as '471' You can also use the number '471' as a password.

## 4-11 How to Restore Default Settings

By doing the procedure shown below, all the parameters will be restored to the default settings set before the unit was shipped.

The key-lock function is also unlocked using this procedure. This can allow a third party to alter the settings on the unit. Please keep this manual with authorized personnel only and in a safe place for future reference.

### How to Restore Default Settings

Key Operation	TEMP Display
<p><b>1</b> Press these the following keys simultaneously for over 5 seconds, while the preset temperature display is shown.</p> <div data-bbox="143 738 344 794" style="text-align: center;"> </div>	<p><b>The preset temperature is displayed.</b></p>
<p><b>2</b> All settings are restored to the factory default.</p> <div data-bbox="134 946 364 978" style="text-align: center; background-color: black; color: white; padding: 2px;"> <b>Setting completed</b> </div>	<p><b>The preset temperature display flashes 5 times.</b></p> <div data-bbox="669 938 856 1023" style="text-align: center;"> </div> <p><b>Returns to the set temperature display.</b></p>

Though the key lock can be released by doing the procedure shown above, the code number cannot be reset.

To reset the code number, follow the procedure for "Resetting the Code Number" shown on page 23.





## 5 Maintenance



### CAUTION

The soldering unit is designed so the tip can be replaced without turning OFF the power. However, the tip is very hot. Do not touch the tip or serious burns may result. The removed tip should be placed in the hole in the iron stand tip end first and kept in there until it cools down.

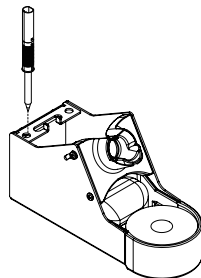

### 5-1 How to Change the Tip

1. Slide the lever on the soldering unit in the direction of the arrow.

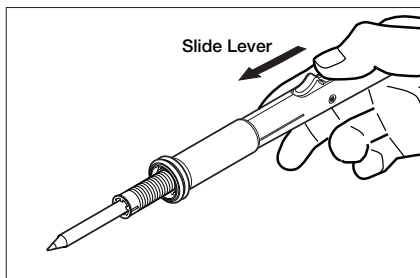

2. Hold the part marked A and pull the tip out in the direction of the arrow. The electricity to the soldering unit automatically goes off as soon as the lever is slid forward to remove the tip.

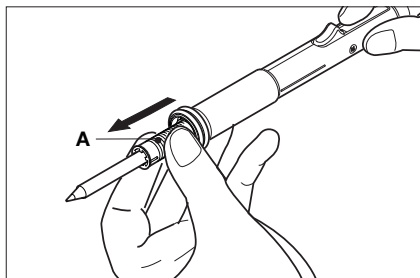

3. Plug the new tip into the end of the soldering unit making sure that the cut part of the tip is aligned with the cut part of the soldering unit. Push the tip into the handpiece as far as it will go. The tip will not heat up until any key on the control unit keypad is pressed.

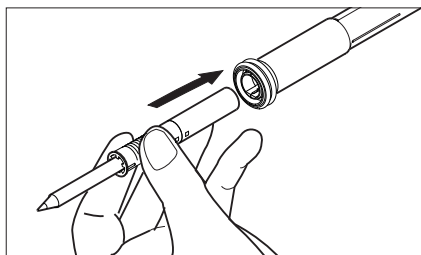

4. Press any key on the keypad to start the flow of electricity to the heater.

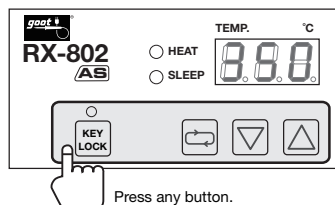

**NOTE** ) When changing to a different type of tip, be sure to input the Tip No. (Refer to **page 11**) Since the heater is integrated into the tip, replacement of only the heater or the tip is not possible.

## 5-2 How to Change the Grip Rubber

1. Remove the screw. Turn and pull the grip adapter to remove the grip rubber.
2. Remove the old grip rubber and replace with new one.

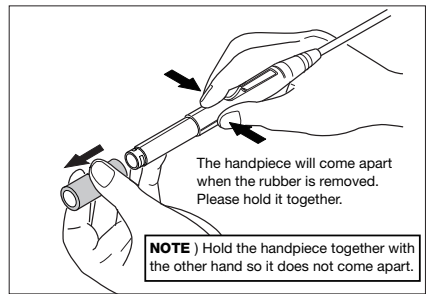
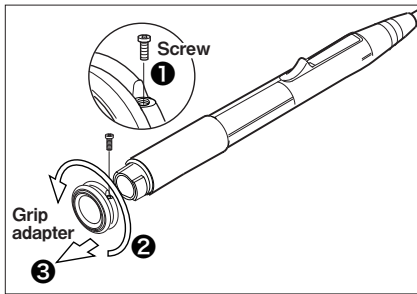

## 5-3 Housing Cleaning

When cleaning, do not at any time allow gasoline, petroleum-based products, penetrating oils, etc. to come into contact with the plastic parts. They contain chemicals that can damage, weaken, or destroy plastics.

## 5-4 How to Use, Clean, and Maintain a Lead-Free Soldering Iron

A lead-free soldering iron is more susceptible to oxidation, and it is more difficult to wet the tip with solder. Flux within the solder adheres to the tip, carbonizes and blackens. This cannot be stopped. However, if the user follows the instructions for use and maintenance below, the user will be able to easily wet the tip with solder consistently.

### How to use, clean, and maintain the soldering iron

#### Recommended temperature

The lead-free soldering iron should be set at a low temperature. This slows down carbonization. Lead-free soldering irons have excellent heat recovery. Reducing the temperature will not affect the work being carried out. However even at lower temperatures, flux still carbonizes.

#### Cleaning tips

During and after use, rub the tip over the sponge or in and out of the wire pad while hot to remove the oxidized blacken particles from the tip. Then, re-tin the tip with a small amount of solder.

#### Applying solder

Be careful to keep the solder only in contact with the solder-coated area of the tip.

#### Using the soldering iron stand

After purchase, the first time you plug in the soldering station, or when resting the iron in the stand during use, leave a coating of solder on the solder-coated area of the tip and place it into the soldering iron stand. Only a thin layer of solder is necessary. The tin surface of a lead-free soldering iron oxidizes easily. Coating it with solder reduces oxidation levels.

Oxidation starts as soon as the tool is plugged in and begins to heat. When operation is completed, tin the solder-coated area of the tip with solder and unplug it. This protects the tip from oxidation when it starts heating up the next time it is in use.

### What to do when the tip is blackened and not 'wetable'

Using a clean sponge, repeat the process of 'tinning' and 'cleaning' the tip several times. The tip surface of an iron that has been in use a short time, generally has a higher 'wettability' recovery level.

If this does not remove the discoloration, use a fine grit sandpaper (eg., #600 grit) to remove any black solid particles and try to 'tin' it with solder once more.

### Washing and replacement of the cleaning sponge

If the cleaning sponge appears black or brown, rinse out the stains in water. If rinsing doesn't remove the stains, replace the sponge.

## 6 Troubleshooting

Read the items below before sending for service or repair.



### The power does not go ON.

→ Check that the power cord is plugged in.

→ Check that the fuse is not blown.

### The soldering iron tip does not heat up.

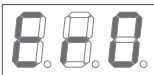
→ Check that the heater is not damaged.

Error message	Cause	Countermeasure
 <p>S o P</p>	The sensor or cord is damaged.	Replace the tip or soldering unit. This message is also displayed when changing the tip but this is not an error. Press any key on the panel.
 <p>E r O</p>	Memory error.	If the unit is not in continuous use, please take it to the nearest dealer for repair.
 <p>H t A</p>	Sensor error, heater error.	The sensor in the tip and/or the heater may be damaged. Replace the tip with a new one. Turn the unit OFF and turn it ON again.
 <p>E H t</p>	Sensor error.	There is a problem with the sensor. Replace the tip. Turn OFF the unit, and then turn the power switch ON again after changing the tip.

# 7 Replacement Tips

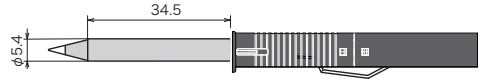

<b>RX-80HRT-B</b> 	<b>RX-80HRT-2B</b> 	<b>RX-80HRT-5B</b> 	<b>RX-80HRT-LB</b> 
<b>RX-80HRT-LBJ</b> 	<b>RX-80HRT-BM</b> 	<b>RX-80HRT-1BC</b> 	<b>RX-80HRT-2.3BC</b> 
<b>RX-80HRT-3BC</b> 	<b>RX-80HRT-0.5C</b> 	<b>RX-80HRT-1C</b> 	<b>RX-80HRT-2C</b> 
<b>RX-80HRT-2CD</b> 	<b>RX-80HRT-3C</b> 	<b>RX-80HRT-3CD</b> 	<b>RX-80HRT-4C</b> 
<b>RX-80HRT-4.7C</b> 	<b>RX-80HRT-0.8D</b> 	<b>RX-80HRT-1.2D</b> 	<b>RX-80HRT-1.6D</b> 
<b>RX-80HRT-2.4D</b> 	<b>RX-80HRT-3.2D</b> 	<b>RX-80HRT-5.4D</b> 	<b>RX-80HRT-3K</b> 
<b>RX-80HRT-4.5K</b> 	<b>RX-80HRT-4.5KH</b> 	<b>RX-80HRT-5.5K</b> 	

## 8 Replacement Parts

For replacement parts, contact a *goot* distributor.

NO.	Item	Parts No.	Note
1	<b>RX-802AS Soldering unit</b>	RX-80GAS	Tip is not included
2	Soldering Iron Stand	ST-21	<b>STAND FOR RX-8 SERIES</b>
3	Soldering Iron Stand Sponge	ST-53SP	Replacement sponge for <b>ST-21</b>
4	Soldering Iron Stand Cleaner	ST-40BW	Replacement Brass shaving for <b>ST-21</b> (2pcs./set)





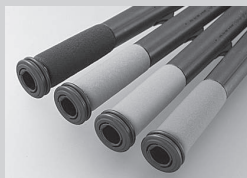
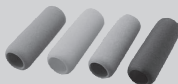





### Grip Rubber Selection

Four different colors available.  
Handy to differentiate stations  
being used for different tasks in  
the same workspace.



Grip rubber (gray)	RX-80RB	Anti-Static
Grip rubber (black)	RX-80RB-BK	
Grip rubber (orange)	RX-80RB-OR	
Grip rubber (green)	RX-80RB-GR	

## 9 Parameters

Term (display panel letters)	Display Panel	Unit	Range	Shipping Default Setting
Set Temperature (PT)		°C °F	(SSt + 50)—450 (SSt + 90)—842	250 482
Tip Number (tPn)		—	0—5	1
Temperature Calibration (cAL)		°C °F	-50—50 -90—90	0 0
Sleep Set Temp (SSt)		°C °F	0—(Pt - 50) 0—(Pt - 90)	200 392
Sleep Timer (ct)		Minute	0.00—999	5
Sleep Sensitivity (diF)		°C °F	0—20.0 0—36.0	2.0 3.6
Shutdown Start time (SUt)		Minute	0—999	60
Alarm (At)		sec.	---, 0.3—30	---
Upper Limit (H)		°C °F	---, 3—100 ---, 5—180	50 90
Lower Limit (L)		°C °F	---, 3—100 ---, 5—180	50 90
Buzzer Sound		—	ON/OFF	ON
Temperature Scale		—	c / F	c



**SOLDERING EQUIPMENT AND ACCESSORIES**  
**TAIYO ELECTRIC IND.CO.,LTD.**

**Customer service: Contact your nearest distributor**

HomePage: [www.goot.co.jp](http://www.goot.co.jp) E-mail: [info@goot.co.jp](mailto:info@goot.co.jp)

**goot** is registered trade mark of TAIYO ELECTRIC IND.CO.,LTD.